

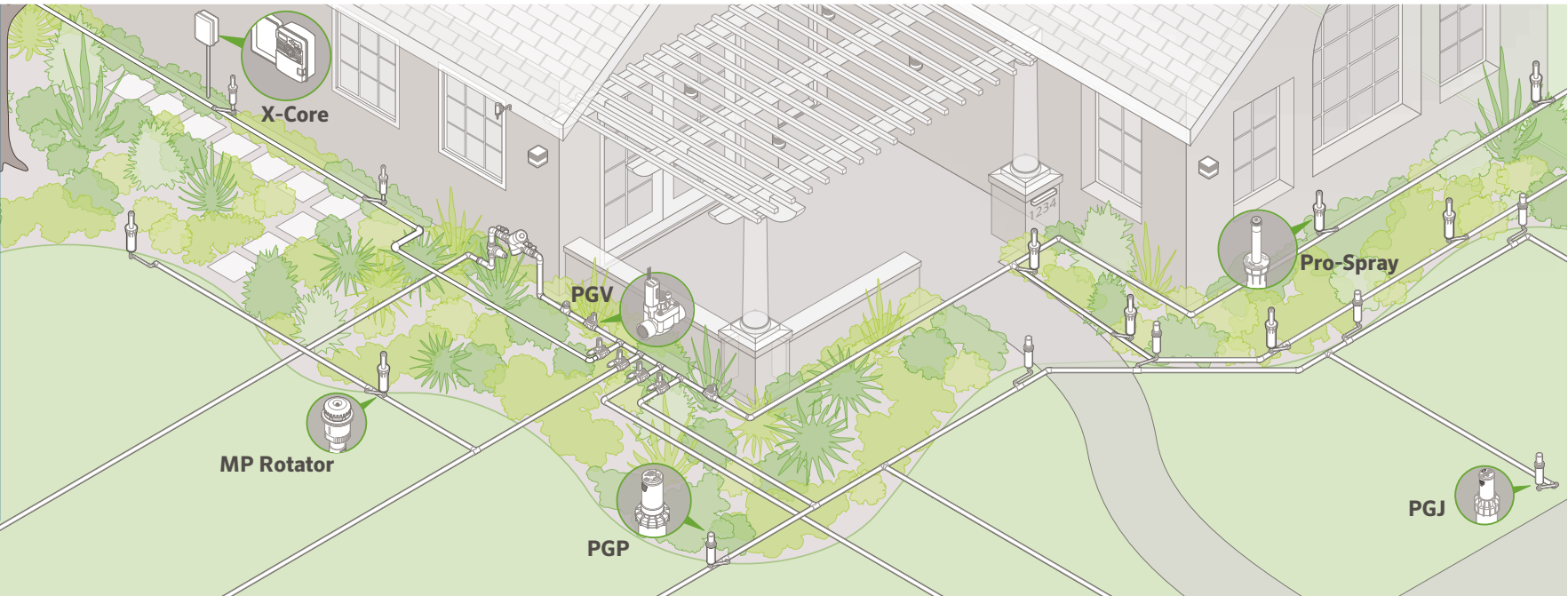

Hunter®

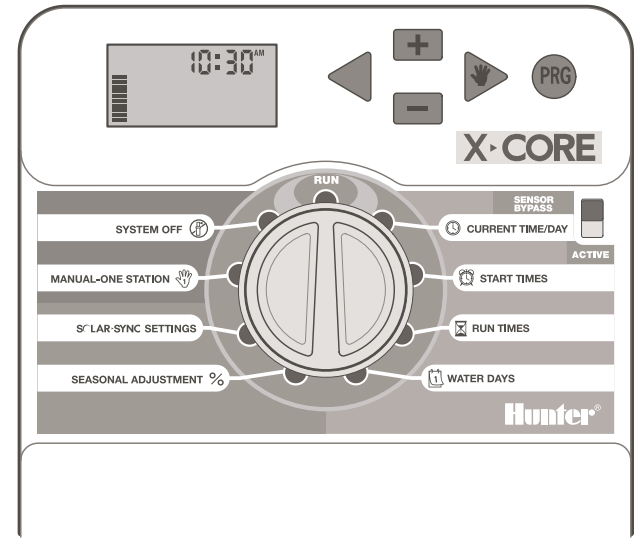

X-CORE

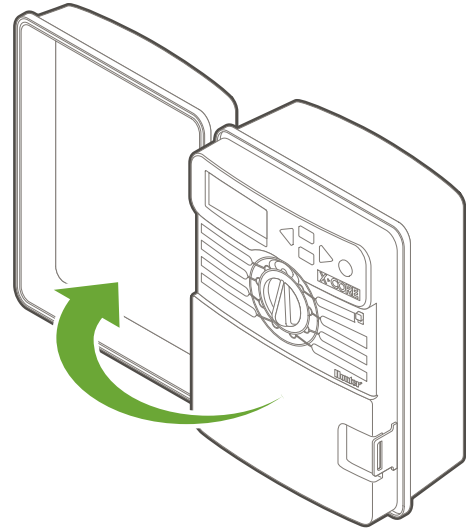

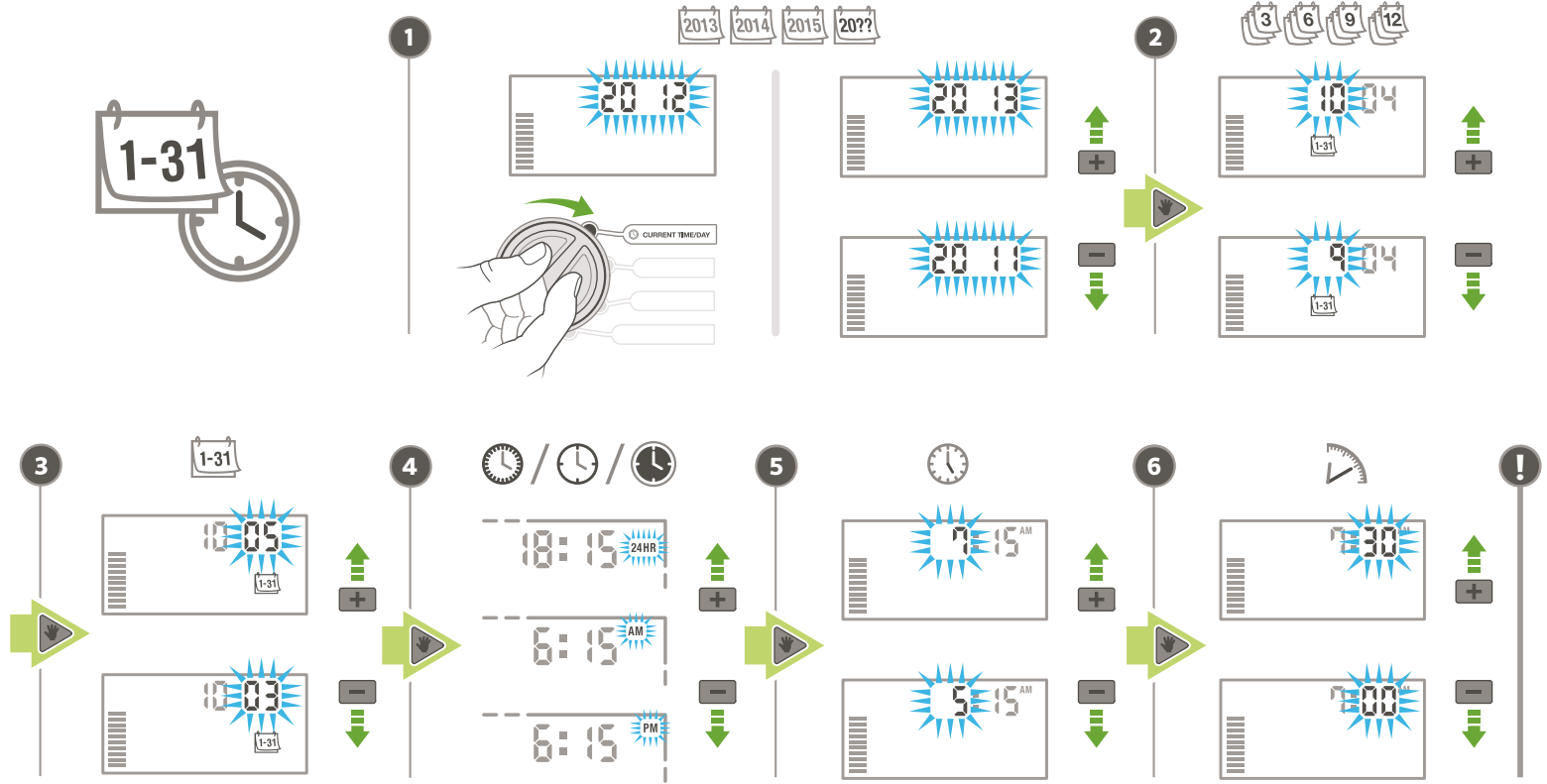

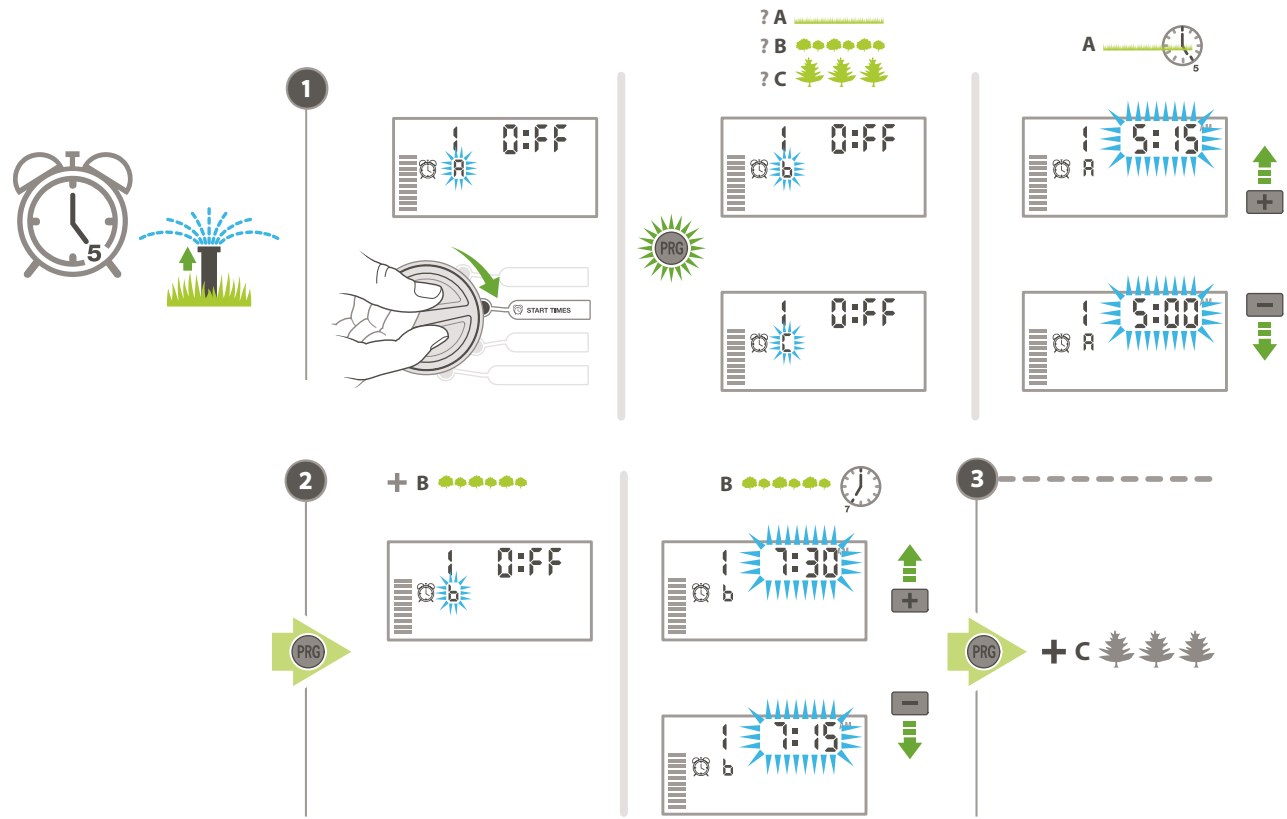

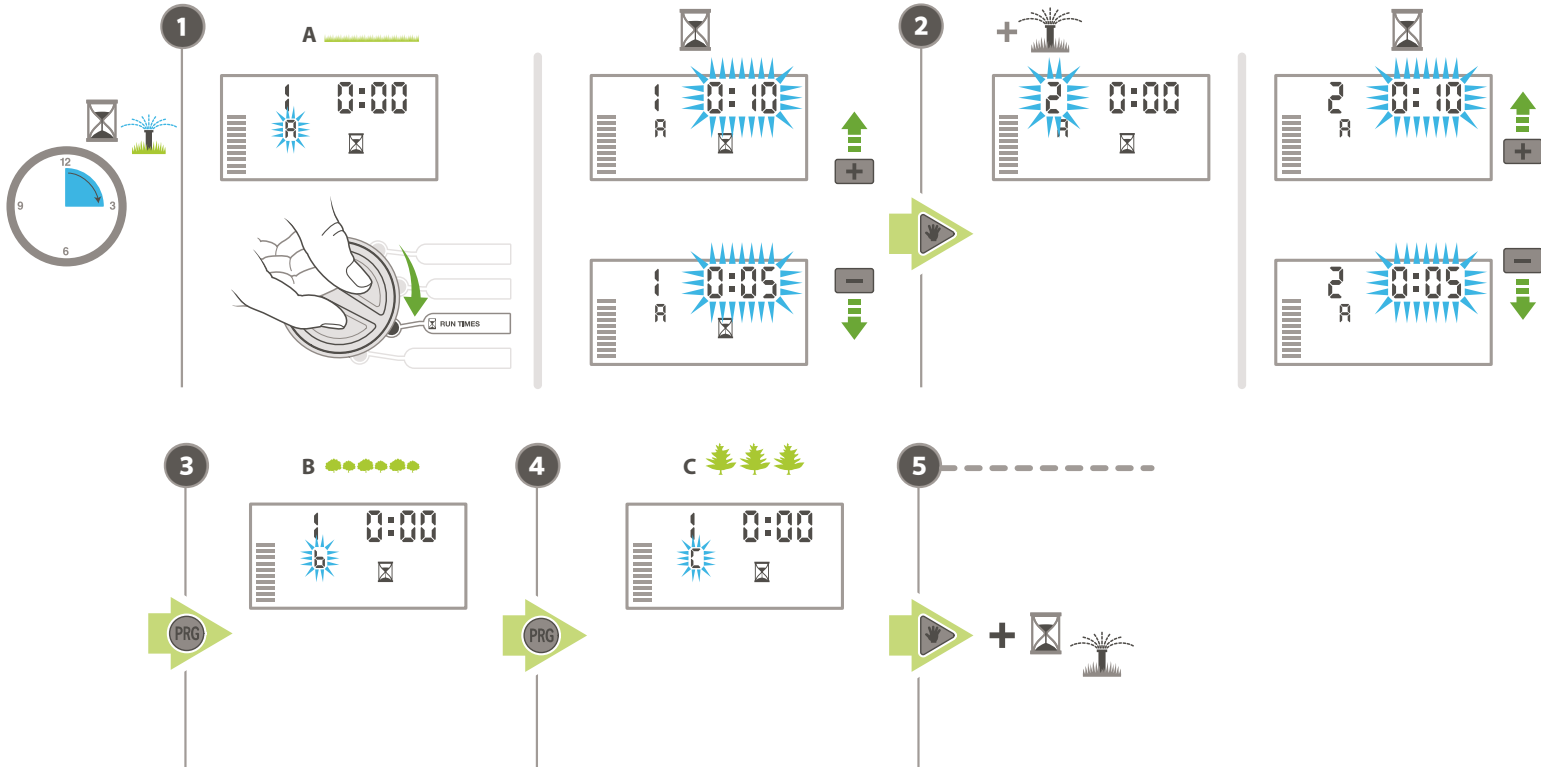

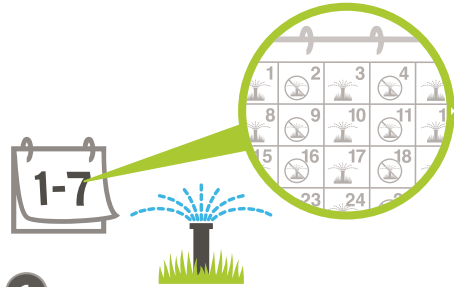

1

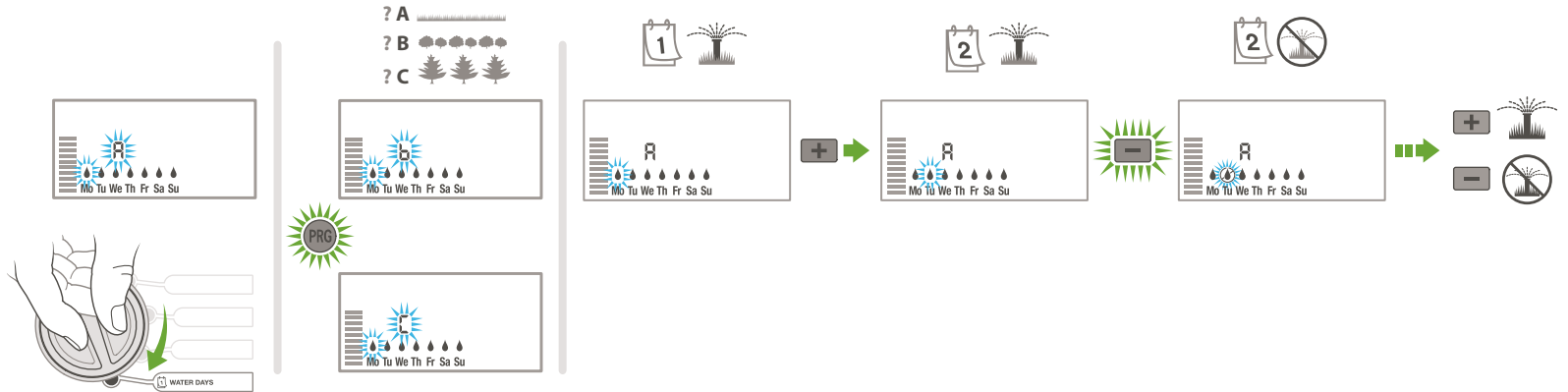

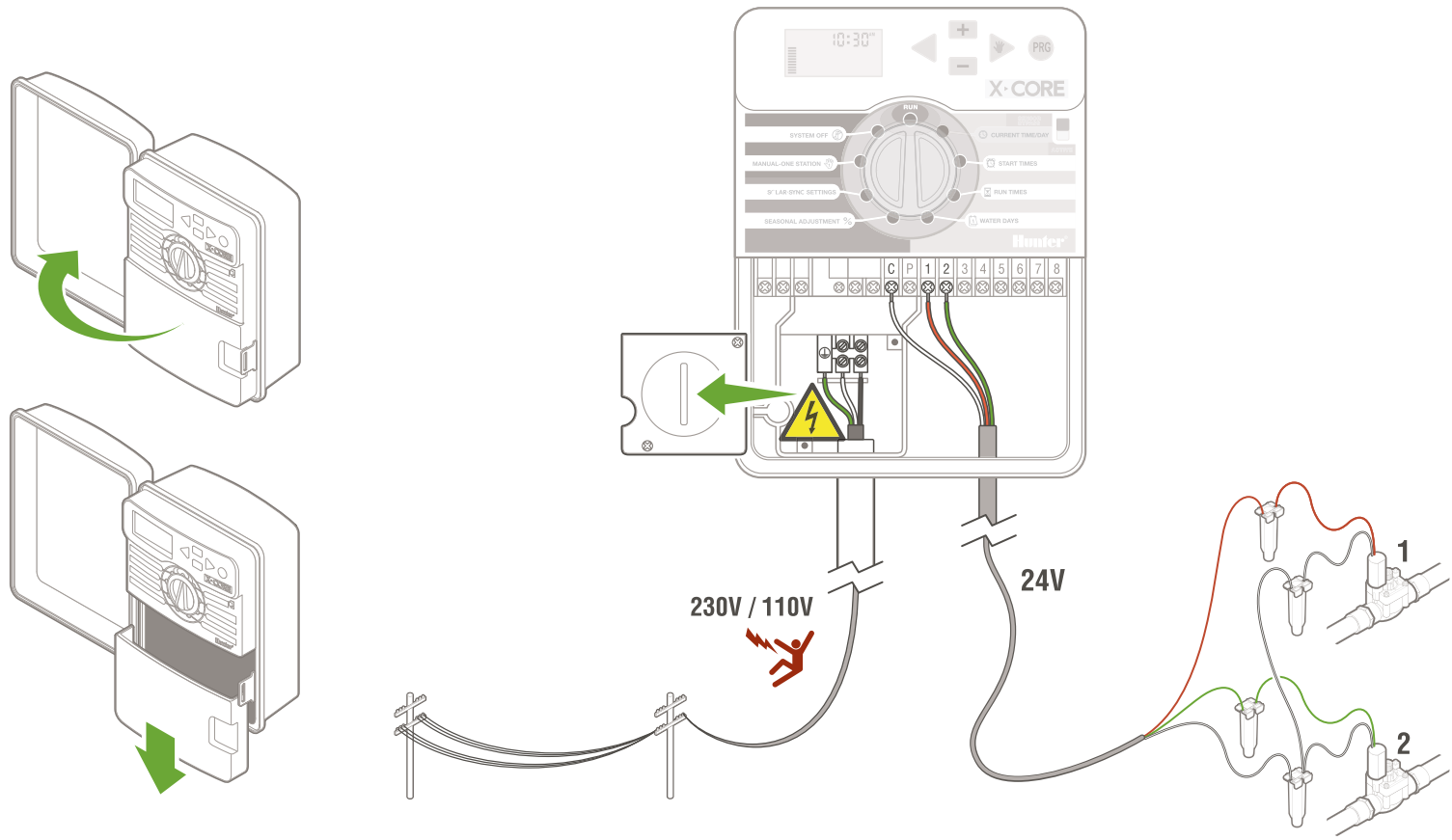

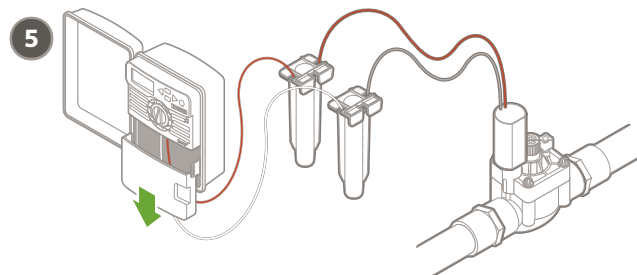
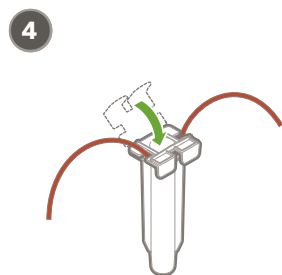
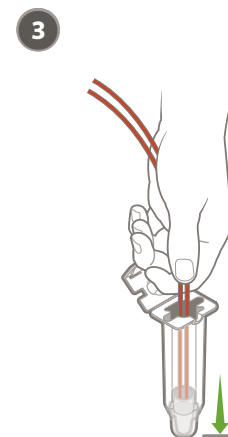
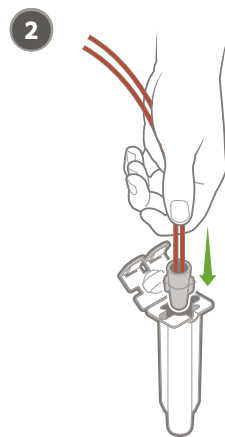
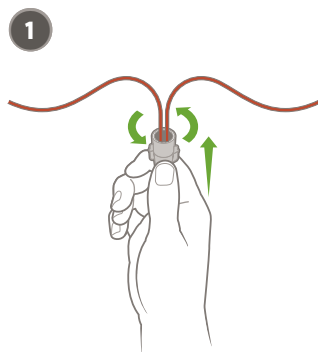

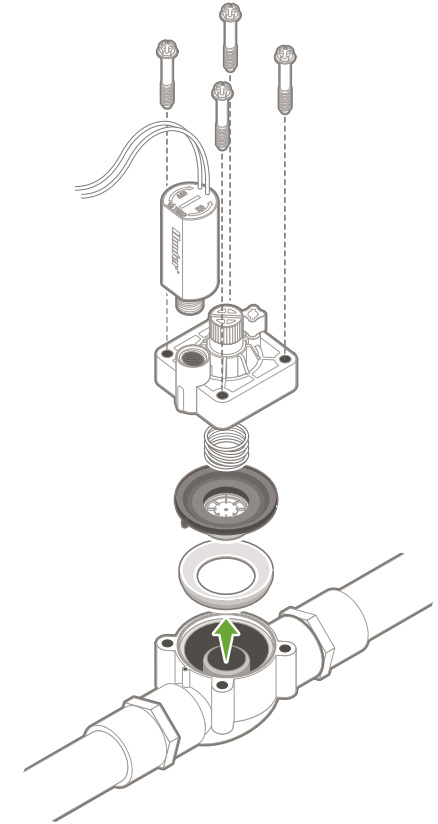
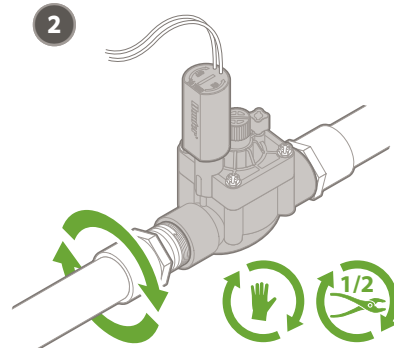
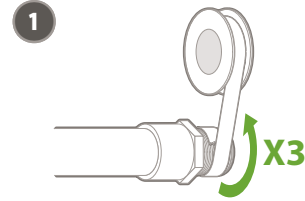
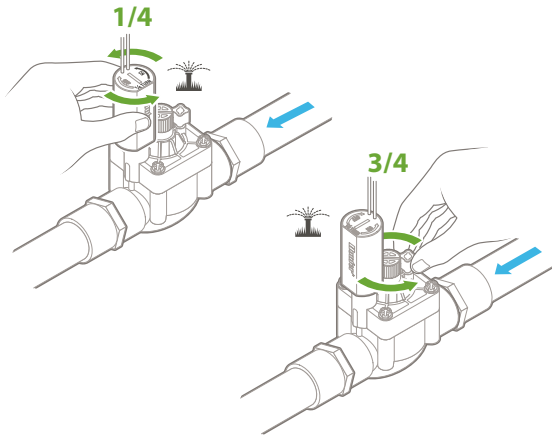
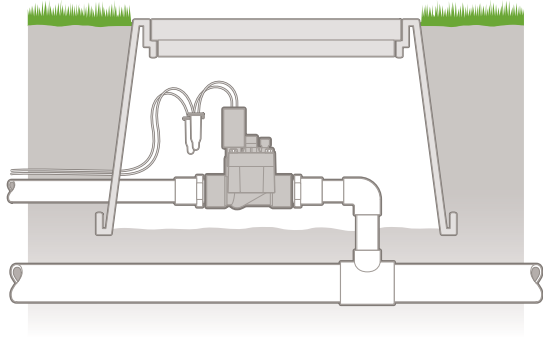

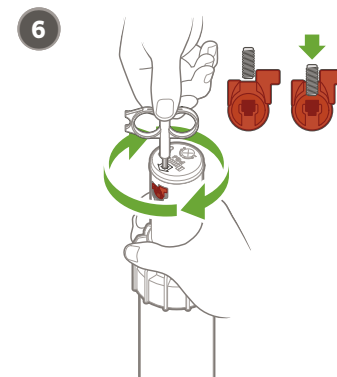
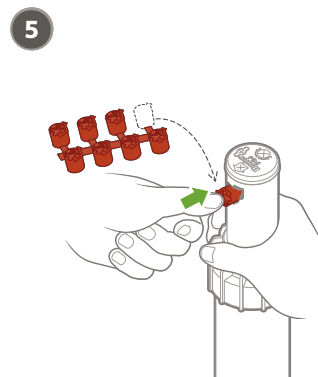
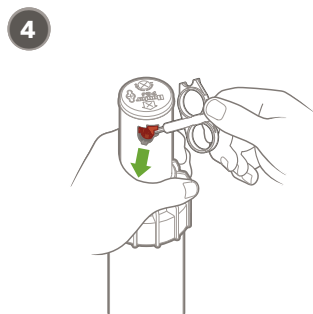
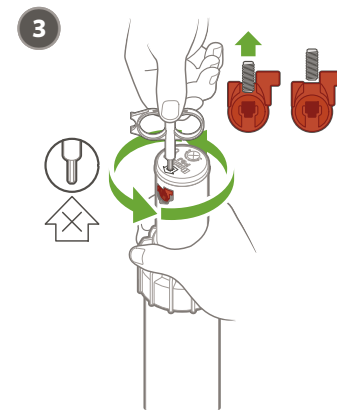
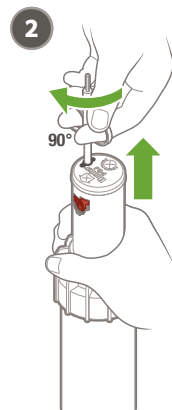
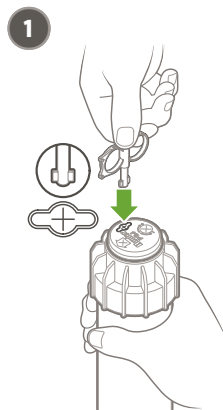

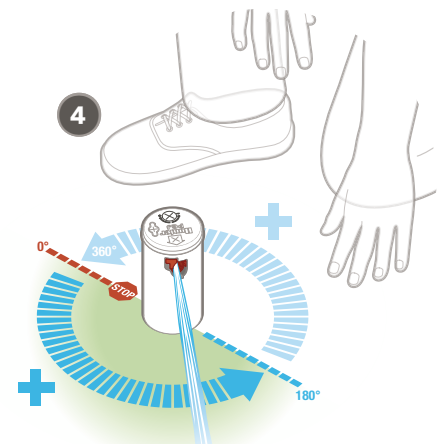
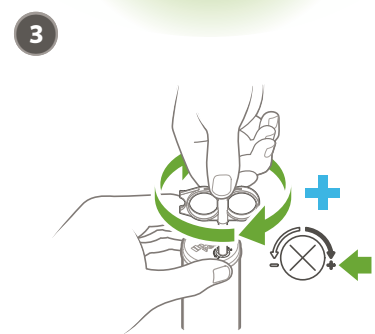
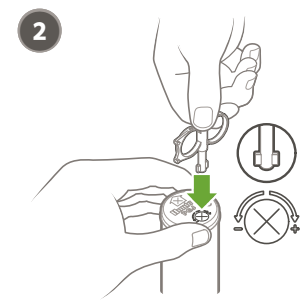
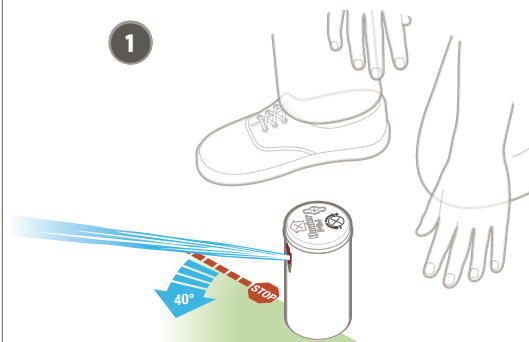
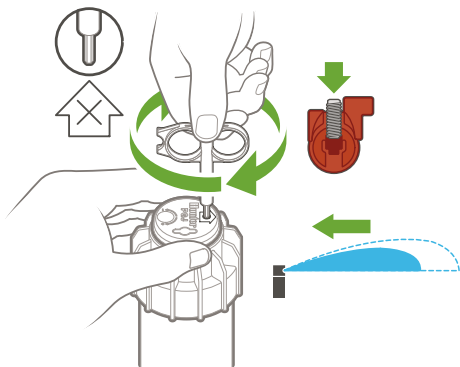
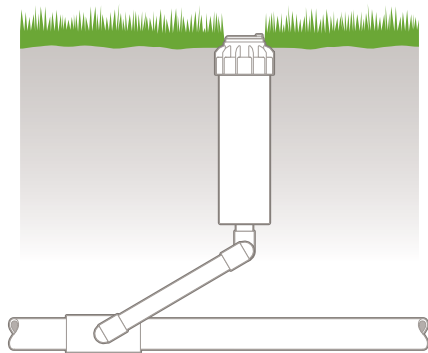



.75



1.7-3.8 Bar
 170-380 kPa
 30-50 PSI



2.2-3.4 l/m
 0.6-0.9 GPM





1.0



1.7-3.8 Bar
 170-380 kPa
 30-50 PSI

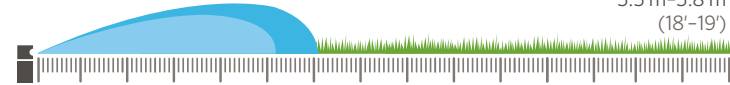

3.0-4.2 l/m
 0.9-1.1 GPM





1.5



1.7-3.8 Bar
 170-380 kPa
 30-50 PSI

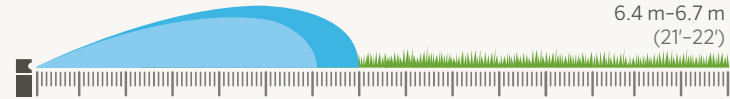

4.5-6.7 l/m
 1.3-1.7 GPM





2.0



1.7-3.8 Bar
 170-380 kPa
 30-50 PSI

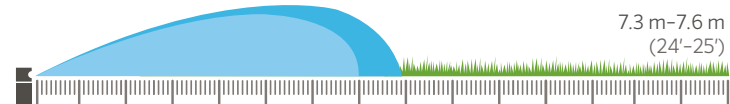

5.6-9.3 l/m
 1.7-2.3 GPM





2.5



1.7–3.8 Bar
 170–380 kPa
 30–50 PSI

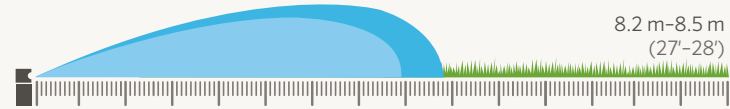

7.6–10.9 l/m
 2.2–2.8 GPM





3.0



1.7–3.8 Bar
 170–380 kPa
 30–50 PSI

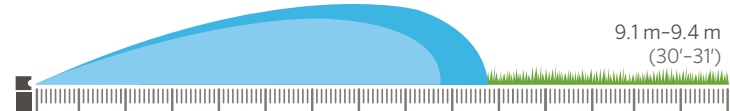

8.5–13.7 l/m
 2.5–3.4 GPM





4.0



1.7–3.8 Bar
 170–380 kPa
 30–50 PSI

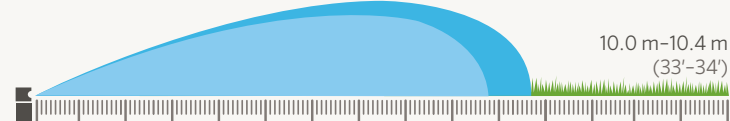

13.3–16.7 l/m
 3.7–4.3 GPM





5.0



1.7–3.8 Bar
 170–380 kPa
 30–50 PSI

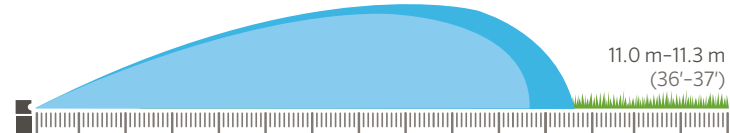

17.0–20.5 l/m
 4.7–5.3 GPM





PGP-ADJ



1

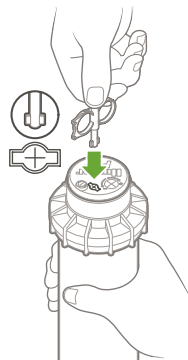

2

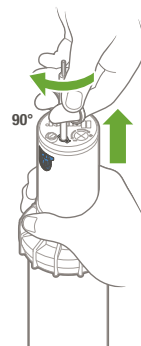

3

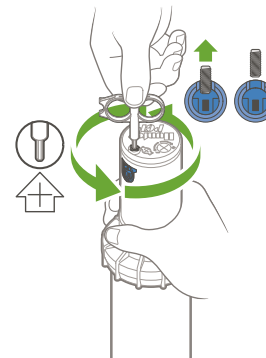

4

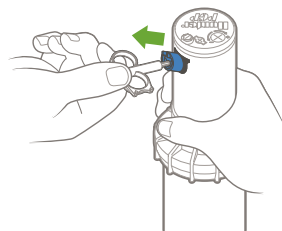

5

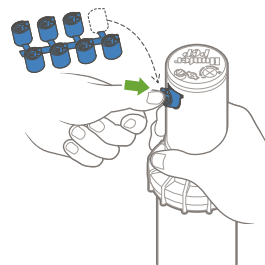

6

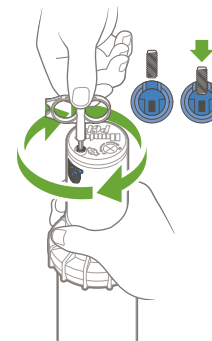

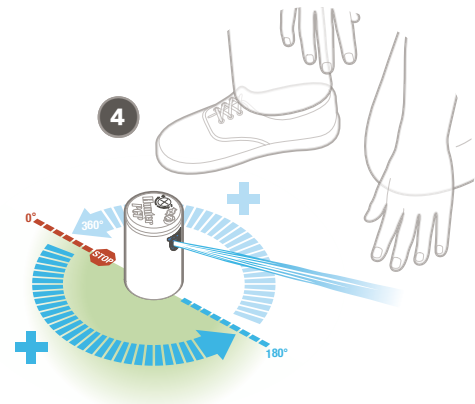
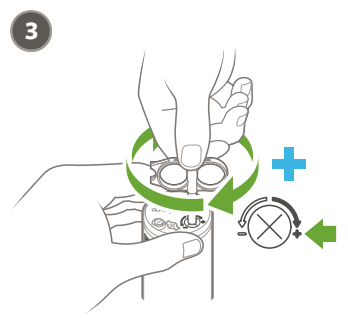
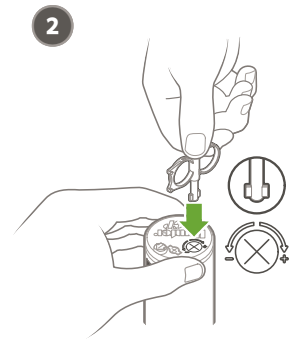
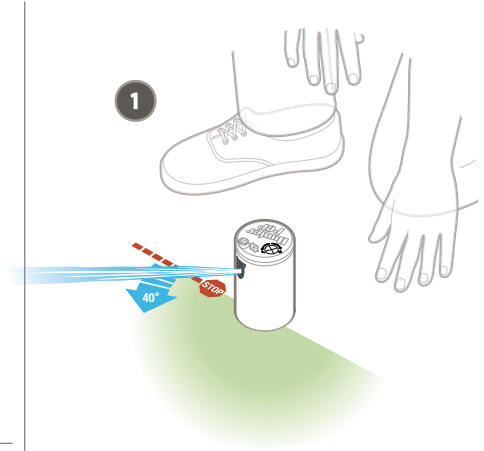
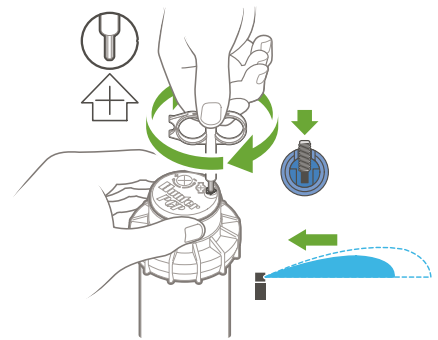
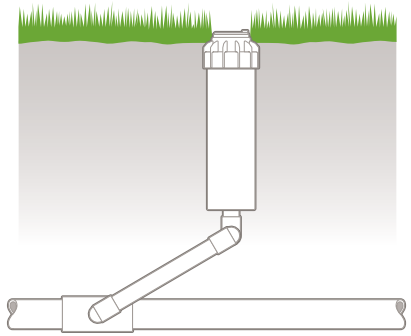



1.5



1.7-4.5 Bar
 170-450 kPa
 25-65 PSI



4.5-7.2 l/m
 1.2-1.9 GPM

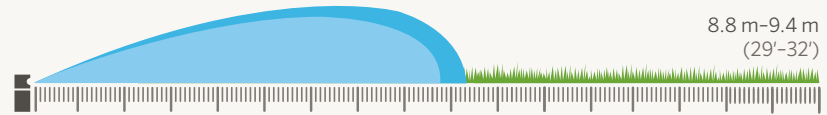

2.0



1.7-4.5 Bar
 170-450 kPa
 25-65 PSI



5.4-8.8 l/m
 1.4-2.3 GPM

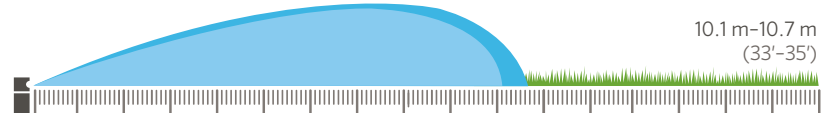

2.5



1.7-4.5 Bar
 170-450 kPa
 25-65 PSI



6.6-11.1 l/m
 1.7-2.9 GPM

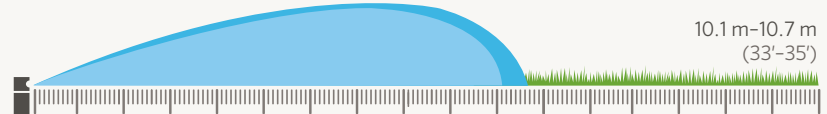

3.0



1.7-4.5 Bar
 170-450 kPa
 25-65 PSI



8.4-14.0 l/m
 2.2-3.7 GPM

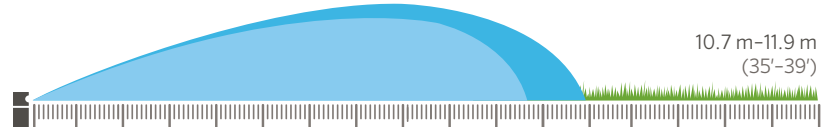



4.0



1.7-4.5 Bar
 170-450 kPa
 25-65 PSI



11.3-18.3 l/m
 3.0-4.8 GPM

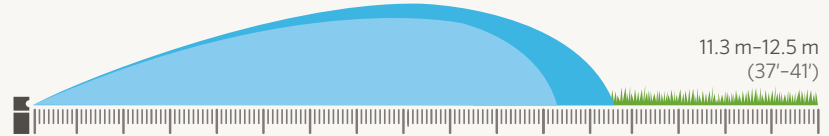

5.0



1.7-4.5 Bar
 170-450 kPa
 25-65 PSI



14.0-23.4 l/m
 3.7-6.2 GPM

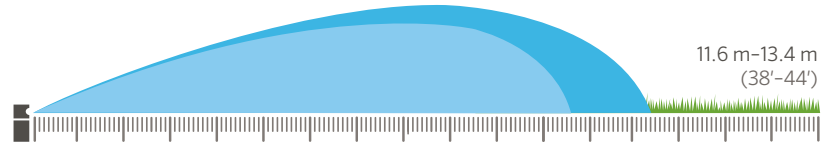

6.0



1.7-4.5 Bar
 170-450 kPa
 25-65 PSI



16.8-27.9 l/m
 4.3-7.3 GPM

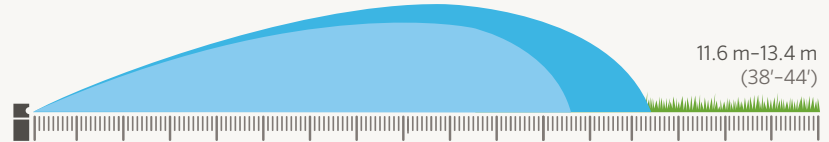

8.0



1.7-4.5 Bar
 170-450 kPa
 25-65 PSI



22.5-36.9 l/m
 6.0-9.8 GPM

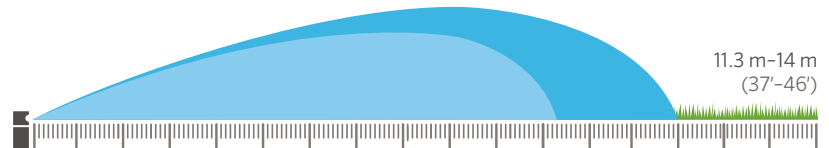

MP ROTATOR

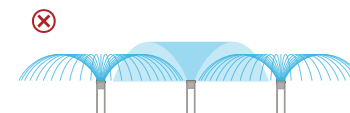
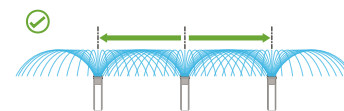
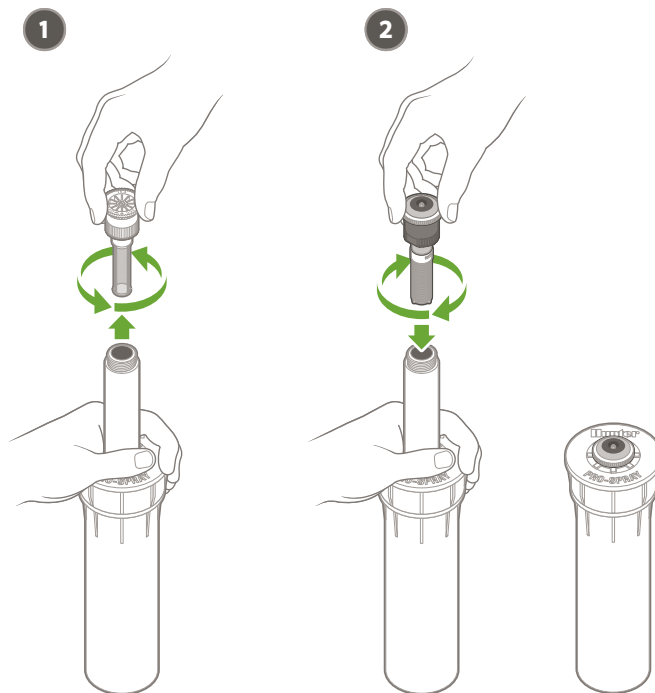

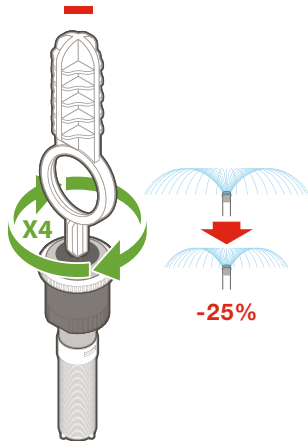
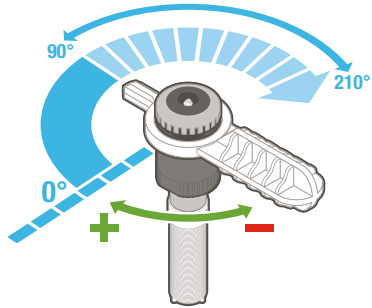

90°-210°



MP100090



210°-270°



MP1000210



360°



MP1000360



MP1000

2.4 m-4.6 m
(8'-15')



MP200090



MP2000210



MP2000360



MP2000

4 m-6.4 m
(13'-21')

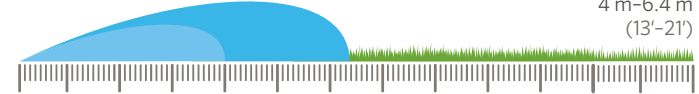

MP300090

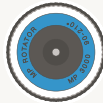

MP3000210



MP3000360



MP3000

6.7 m-9.1 m
(22'-30')

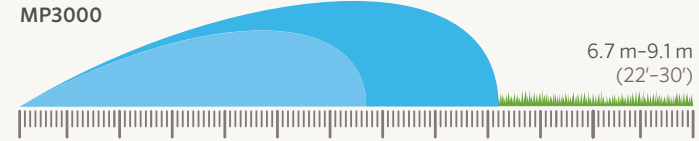

MP350090



MP3500

9.4 m-10.7 m
(31'-35')

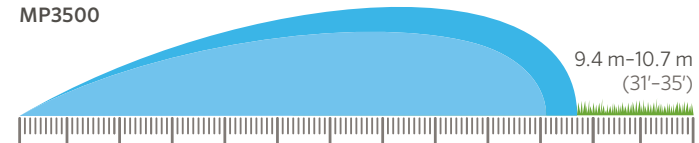

PS ULTRA / PRO-SPRAY



1

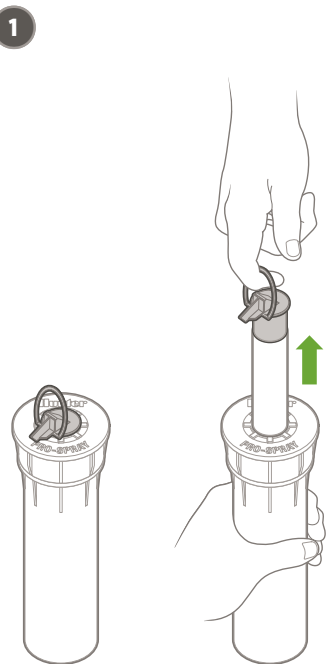

2

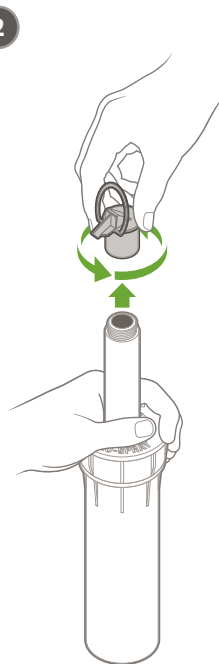

3

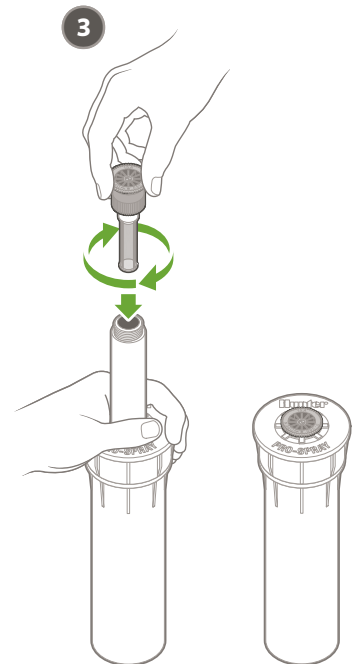

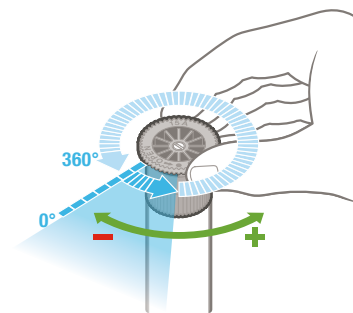
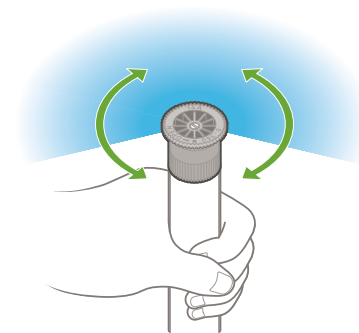
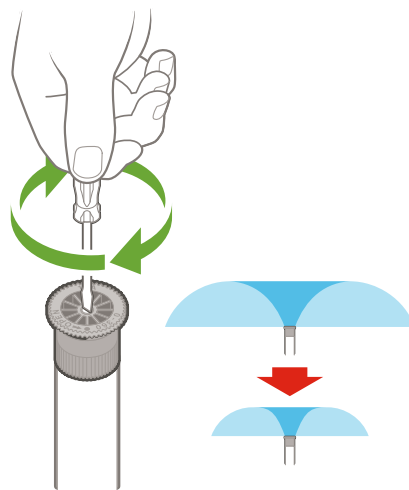
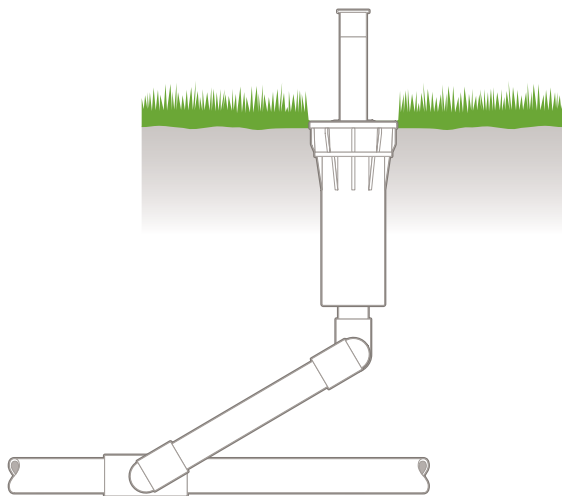

10A



1.0-2.5 Bar
 100-250 kPa
 20-40 PSI



0.6-8.3 l/m
 0.2-2.3 GPM



2.1-3.5 m
 (9'-11')

12A



1.0-2.5 Bar
 100-250 kPa
 20-40 PSI



0.8-10.7 l/m
 0.3-3.0 GPM



2.7 m-4.2 m
 (11'-13')

15A



1.0-2.5 Bar
 100-250 kPa
 20-40 PSI



1.2-15.8 l/m
 0.4-4.7 GPM



3.4 m-5.2 m
 (14'-17')

17A



1.0-2.5 Bar
 100-250 kPa
 20-40 PSI



1.5-20.4 l/m
 0.5-5.6 GPM



4.7 m-5.7 m
 (16'-19')

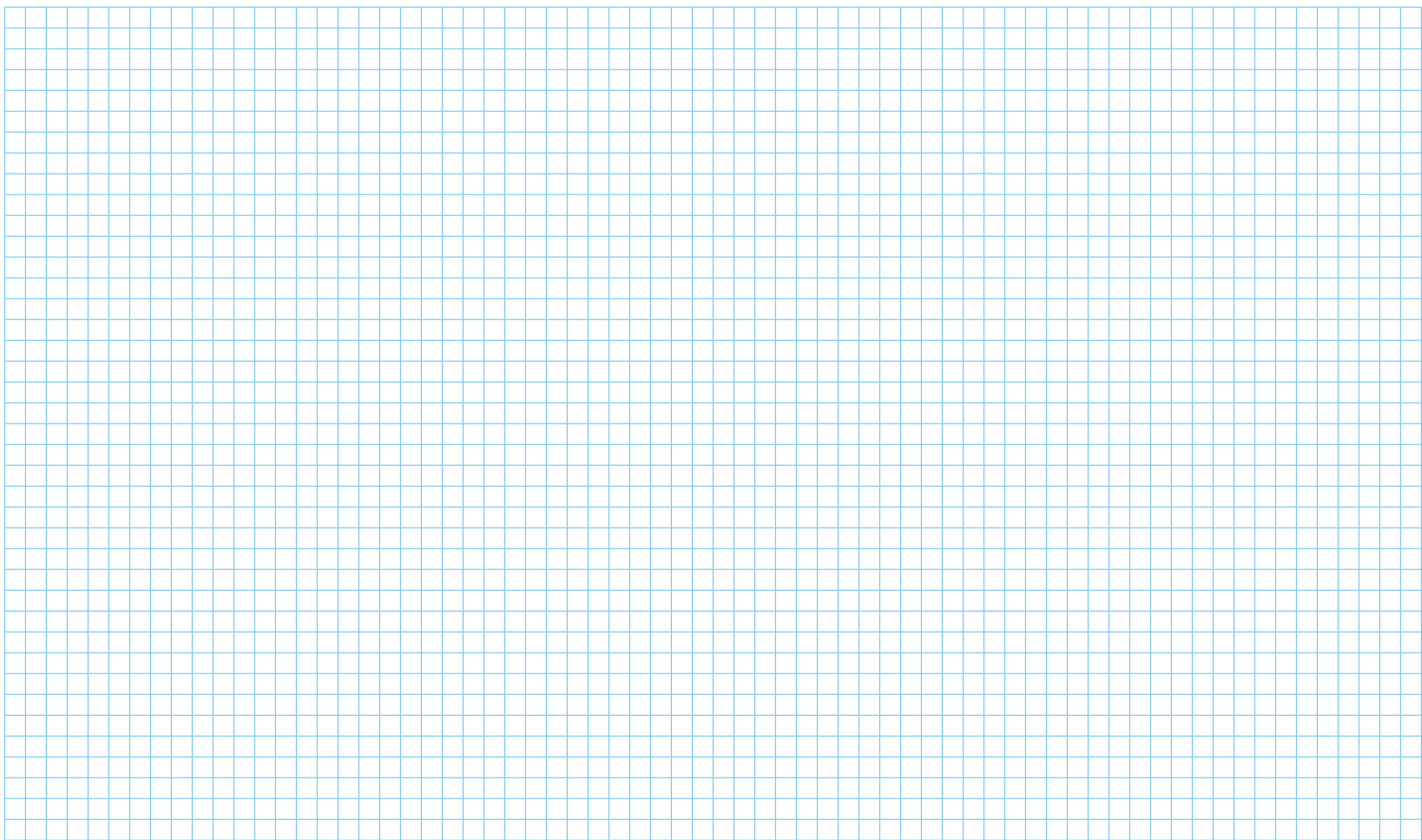

Hunter[®]

